

Name: _____ Date: _____ Event: _____ Track: _____

Track Conditions

Indoor Clay Carpet Tight Smooth Hard Packed Blue Groove Wet Bite: Low Med High Other: _____
 Outdoor Dirt Astro Open Rough Loose/Loamy Dry Dusty Tread: Pin Ghost Slicks

Front Suspension

Ride Height	_____ mm
Camber	_____ °
Toe	_____ °
Sway Bar	_____ mm
Notes:	_____

- 2mm
- 3mm
- 4mm

- 1.0
- 0.5
- 0.0

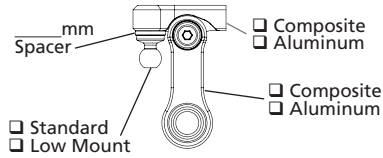

- Standard
- Low Mount

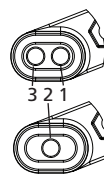
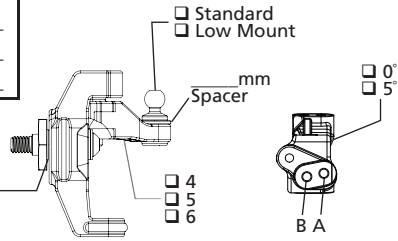

- Composite
- Carbon Std
- Carbon +2mm

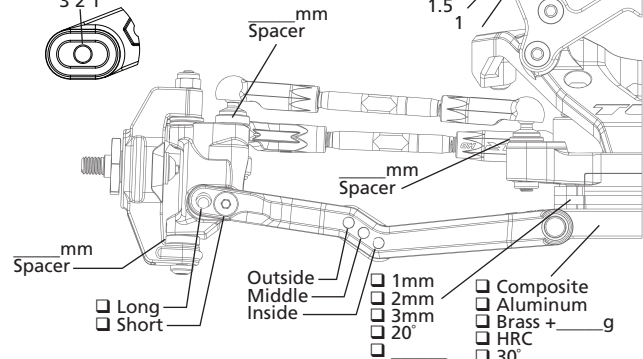

- Long
- Short

- 1mm
- 2mm
- 3mm
- 20°

- Composite
- Aluminum
- Brass + _____ g
- HRC
- 30°

Rear Suspension

Ride Height	_____ mm
Camber	_____ °
Sway Bar	_____ mm
Notes:	_____

mm Spacer

- Composite
- Aluminum

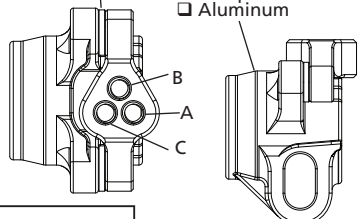

- 4.5
- 5.0
- 5.5
- 6.0
- Std

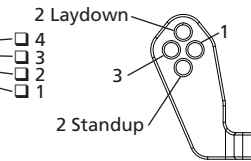

- Composite
- Carbon Std
- Carbon +2mm

- 67mm
- 68mm
- X67mm
- X68mm

- Shock Location
- Front
- Rear

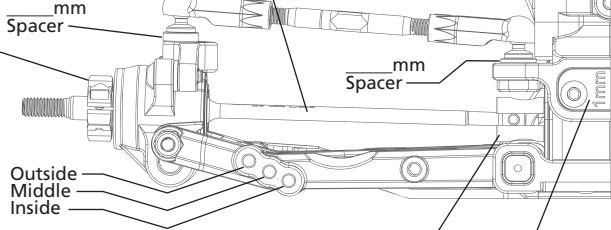

- 0 +1.0 +1.75 +2.5 +3.5 +1 0 -1

Chassis

Drive Train	
Diff Type	<input type="checkbox"/> Ball Diff <input type="checkbox"/> Gear Diff
Setting/Fluid	
Internal Gears	<input type="checkbox"/> Steel <input type="checkbox"/> Composite
Planet Gears	<input type="checkbox"/> 2 <input type="checkbox"/> 4
Slipper	<input type="checkbox"/> Slipper <input type="checkbox"/> Direct Drive
Slipper Pads	<input type="checkbox"/> Torque/Yellow <input type="checkbox"/> Drive/Orange

Aerodynamics	
Body	
Fr Wing	
Rr Wing	
Wicker	
Angle	_____ °
Notes	

Tires		
	Front	Rear
Brand		
Tread		
Compound		
Insert		
Sauce		
Wheel	<input type="checkbox"/> Standard <input type="checkbox"/> Stiffezel	
Notes		

Shocks

	Front	Rear
Shock Caps		
Oil		
Piston	<input type="checkbox"/> Thin	<input type="checkbox"/> Thin
Limiters, Int	_____ mm	_____ mm
Shaft Dia	<input type="checkbox"/> 3.0mm <input type="checkbox"/> 3.5mm	<input type="checkbox"/> 3.0mm <input type="checkbox"/> 3.5mm
Limiters, Ext	_____ mm	_____ mm
Stroke	_____ mm	_____ mm
Eyelet	<input type="checkbox"/> Std <input type="checkbox"/> +2mm	<input type="checkbox"/> Std <input type="checkbox"/> +2mm
Spring		
Spring Cup	<input type="checkbox"/> Low <input type="checkbox"/> Mid <input type="checkbox"/> High	<input type="checkbox"/> Low <input type="checkbox"/> Mid <input type="checkbox"/> High

Electronics			
Radio		ESC	
Servo		Thro Prof	
Battery		Timing Adv	
Battery Wt	_____ g	Initial Brake	
Motor		Drag Brake	
Gearing	/	Thr/Bra EPA	/

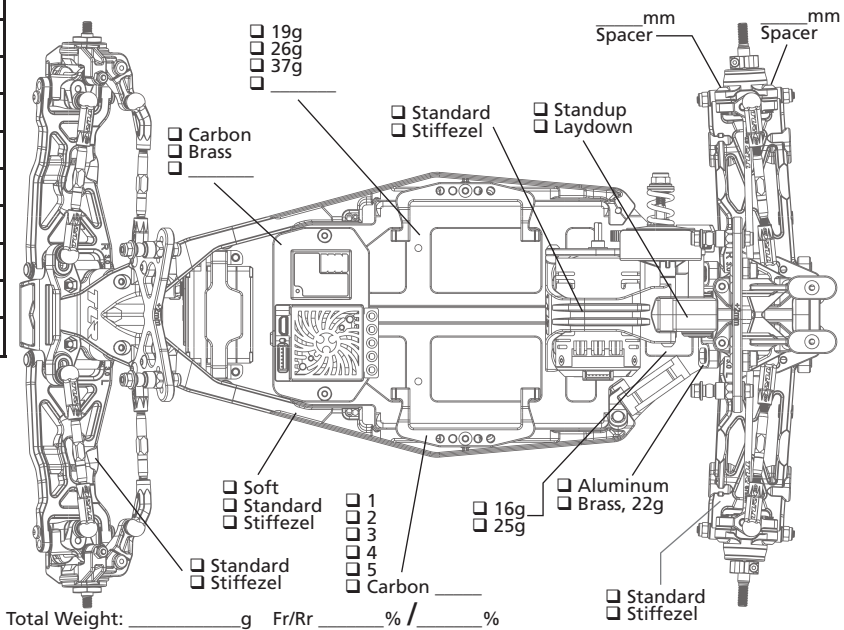

Total Weight: _____ g Fr/Rr _____ % / _____ %